



Characterization of
particles • powders • pores

mixSorb Series

- Breakthrough curves
 - Multi component adsorption
 - Sorption kinetics
-
- Fully automated control via PC
 - Temperature range: ambient –400 °C
 - Pressure range: 0.1–68 bar
 - Adjustable gas flow rates up to 40 L/min
 - Additional accessories and tools



Dynamic Adsorption
of Gases and Vapors

Introduction

Industrial adsorbents such as activated carbons, zeolites and silica gels are widely used in adsorptive separation processes on a multi-ton scale. The after-treatment of exhaust gases, the removal of carbon dioxide in biogas plants, purification and fractionation of natural gas, air separation, respiratory protection and separation of isomers are just few examples where adsorptive separation is employed as the most efficient and economic separation technique. A complete understanding of the complex processes taking place in a fixed bed adsorber is the key to achieving the best separation performance.

Additionally, mixed gas adsorption on novel materials, like MOFs COFs etc., have moved into the focus of research within the last years. These materials can have very high selectivities due to their extraordinary surface chemistry and have to be investigated by mixed gas sorption for a deeper understanding of their sorption behavior.

The mixSorb series provides unique capabilities to investigate complex dynamic sorption processes in a uniquely safe and easy-to-use bench-top instrument. Industrial

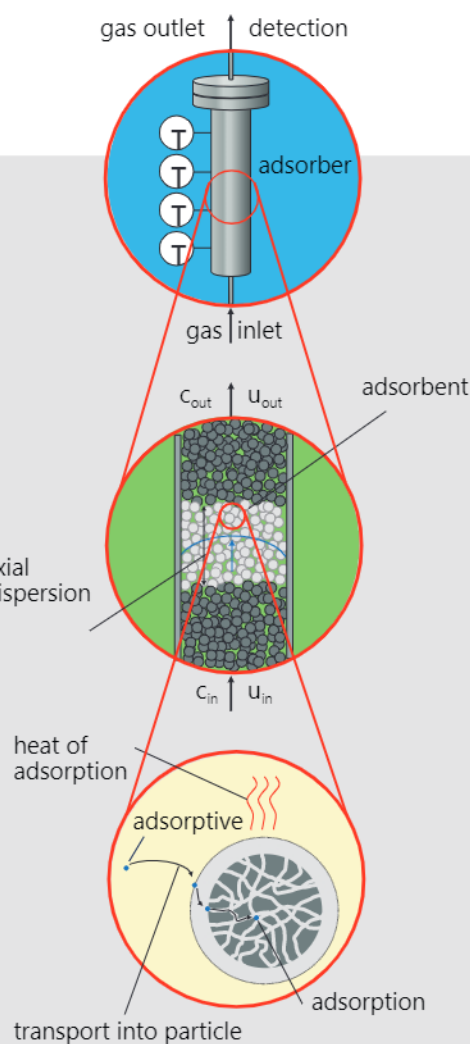

Figure 1 The interior of an adsorber

adsorbents and small sample amounts of R&D samples can be investigated under real-world process conditions in a broad temperature and pressure range with adjustable gas flow rates and well-defined gas compositions.

Adsorber

The different stainless-steel adsorbers can accommodate typical sample sizes of industrial adsorbents for fixed bed simulation with representative gas flows and compositions or small samples of novel powders to investigate gas mixture equilibria. Sample preparation can be performed in-situ using either inert gas flux or vacuum at temperatures up to 400 °C. Regulating the temperature of the inlet gas and the adsorber allows for uncompromised temperature control throughout the measurement. High precision mass flow controllers are used for quick and stable gas mixing and flow rate control. The adsorber pressure is regulated automatically and the pressure drop between adsorber inlet and outlet will be measured by the instrument.

Applications

- Determination of breakthrough curves
- Investigation of kinetic performance of adsorbents
- Investigation of co-adsorption and displacement phenomena
- Determination of sorption selectivity
- Dynamic adsorption and desorption experiments
- Determination of single- and multi-component adsorption data
- Investigation of heat profiles along the adsorber bed
- Measurement of adsorption in the presence of water or others vapors
- mixSorb L series: Realistic scale-downs of industrial separation processes
- mixSorb S series: Obtain data of dynamic adsorption and desorption experiments with low-mass-powder samples (< 1 cm³)

Safety

A robust adsorber design, protective doors, an illuminated working area, and a clearly structured PC-controlled interface assure safe and convenient instrument operation. The adsorber pressure is continuously measured and displayed on the front of the instrument, even if the instrument is turned off. Work area illumination changes from white to red when the heating mantle temperature exceeds 80 °C, indicating an elevated temperature in the work area. Safety guard sensors for the detection of flammable gases are standard in all mixSorb instruments. In the event of a gas leakage, the instrument is brought to an idle state and shut off automatically.



Gas Purification



Gas Separation



Energy



Carbon

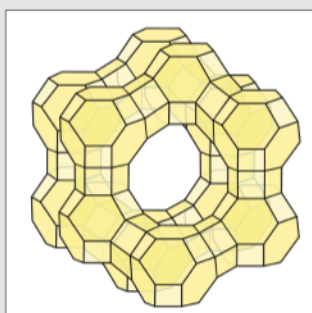

Zeolites

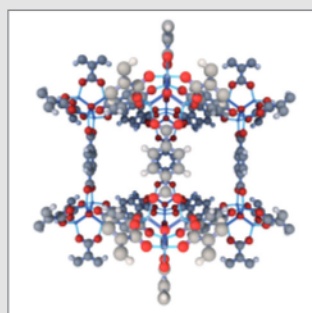

Metal Organic Frameworks

Features

- Easy and intuitive PC-control
- Automated processing of sequential adsorption and desorption experiments
- In-situ sample preparation
- Automated regulation of the adsorber pressure
- Up to 4 high precision mass flow controllers
- Automated built-in gas mixing
- Evaporator option for introduction of water and other vapors
- Measurement of inlet and outlet gas composition
- Temperature control of inlet gas and adsorber
- Determination of heat profiles within the adsorber bed with up to four temperature sensors
- Monitoring of pressure drop along the adsorber
- Built-in thermal conductivity detector (TCD)
- Optional gas analysis with connection to a mass spectrometer
- Safety guard sensor for flammable gases for automatic shut down
- Enhanced safety by intelligent illuminated workspace

Signal Detection

The adsorber outlet gas composition is measured with a built-in Thermal Conductivity Detector (TCD) situated in a thermostatted environment for precise and stable signal detection. The TCD is pre-calibrated by the manufacturer for 13 common gas mixtures. You are working with a different system? No problem! Due to a fully automated bypass calibration, almost any binary mixture can be detected. The additional mass spectrometer control capability allows for the quick and easy interfacing of an optional mass spectrometer.

mixSorb L Series

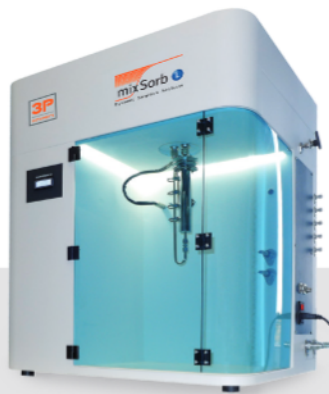

Overview

The **mixSorb L series** opens a new window for the characterization of technical adsorbents. This automatic gas sorption analyzer for measuring sorption breakthrough curves of gas mixtures is the basis for estimating the selectivity of separated product gas. The adsorber column can handle both low gas flow rates and higher gas flow rates up to 40 L/min. Depending on the desired application range, there are four different models available: the mixSorb L (up to 10 bar), mixSorb LHP (up to 68 bar), the mixSorb L ambient (for applications at or below ambient pressures only) and the mixSorb L eco, a more economical version of the L model. The mixSorb is the ideal instrument for downscaling technical separation processes to lab scale.

Benefits

- Large flow range
- Investigation of mixture equilibria and kinetics, downscaling of industrial processes
- Temperature controlled inlet gas and adsorber
- Uncompromised temperature control during analysis
- Automated counter current operation
- Downscaling industrial PSA-processes

Specifications

Model	L	L eco	L ambient	LHP
Pressure range	0.1 – 10 bar	0.1 – 10 bar	0.1 bar – ambient	0.1 – 68 bar
No. of MFCs	2 – 4			
Required inlet pressure	15	15	15	85
No. of evaporators	Up to 2			
Pressure control	Yes	Yes	No	Yes
Simulation software	Incl.	Optional	Incl.	Incl.
Gas sensor	Yes	No	Yes	Yes
Counterflow possible	Yes	No	Yes	Yes
TCD	Incl. 13 factory calibrations	Incl. 1 factory calibration	Incl. 13 factory calibrations	Incl. 13 factory calibrations
Sample bed temperature sensors	Up to 4			
Sample loading	4 – 130 cm ³ , customized adsorbents on requests			
Temperature range heating mantle	Ambient – 400 °C			
Temperature range circulator bath	-20 °C – 90 °C			



Overview

The **mixSorb S series** allows the characterization of novel adsorbents in small powder sample amounts. This automatic gas sorption analyzer for measuring sorption breakthrough curves of gas mixtures is the basis for estimating the selectivity of desired or separated product gas. The adsorber columns are capable of handling flow rates up to 500 mL/min. Depending on the desired application range, there are five different models available: the mixSorb S (up to 10 bar), mixSorb SHP (up to 68 bar), mixSorb S ambient (for applications at or below ambient pressure only) and the eco models of the S and SHP. The eco versions are ideal for those with a limited budget but still need similar testing capabilities. Any way you choose, the mixSorb is the optimal instrument for the determination of mixture adsorption data of advanced materials.

Benefits

- Small dead volume
- Optimized for short dwell times
- Sample volume designed for R&D groups with small powder amounts (< 1 cm³)
- Automated control of the adsorber pressure up to 10 bar
- High flexibility with various optional accessories

Specifications

Model	S	S eco	S ambient	SHP eco	SHP
Pressure range	0.1 – 10 bar	0.1 – 10 bar	0.1 bar – ambient	0.1 – 35 bar	0.1 – 68 bar
No. of MFCs	2 – 4				
Required inlet pressure	15 bar	15 bar	15 bar	85 bar	85 bar
No. of evaporators	Up to 2				
Pressure control	Yes	Yes	No	Yes	Yes
Simulation software	Incl.	Optional	Incl.	Optional	Incl.
Gas sensor	Yes	No	Yes	No	Yes
TCD	Incl. 13 factory calibrations	Incl. 1 factory calibration	Incl. 13 factory calibrations	Incl. 1 factory calibration	Incl. 13 factory calibrations
Sample bed temperature sensors	Up to 4				
Sample loading	< 0.1 cm ³ – 5 cm ³ , customized adsorbents on requests				
Temperature range heating mantle	Ambient – 400 °C				
Temperature range circulator bath	-20 °C – 90 °C				

mixSorb Flexibility & Benefits

Flexibility

Alternative Sample Cells

A small adsorber option allows separation studies with very low concentrations and vapors on high performance materials with short measurement times. Other adsorber sizes as well as customized membrane and filter cells are available on request.

Tempering Options

A single circulating bath can be used for precise temperature control of inlet gas and adsorber between -20 °C and 90 °C. For higher temperatures and in-situ sample activation, a heating mantle up to 400 °C is available.

Mass Spectrometer Option

A mass spectrometer can be controlled using the mixSorb manager software. Control capabilities include turning the filaments on/off, starting/finishing data acquisition and live data integration.

Evaporator Options

One or two high performance tempered saturators are available for water and other liquids to ensure stable vapor feeds up to 68 bar. The fill level of the saturators are displayed in the mixSorb manager software.

Benefits

Built-in Sample Preparation up to 400 °C

Investigation of hydrophilic materials (i.e., zeolites and silica gels).

Linear Heating Rates up to 10 K/min

Slow and controlled heating of sensitive materials.

Automated Gas Mixing

No need for multiple pre-mixed gas tanks, increasing flexibility of measurement conditions.

PC Control and Data Acquisition

Completely programmable for operator-free analysis.

Detection Pressure on Adsorber Inlet and Outlet

Observation of pressure drop in the column.

Built-in Thermal Conductivity Detector (TCD)

Automated time-resolved measurement of outlet gas composition.

Temperature Swing Option

The TSA option allows fast temperature changes (0 °C-140 °C) and can be equipped with an additional evaporator which enables sample regeneration with pure water (vapor) treatment.

Vacuum Option

A vacuum pump can be connected to the instrument. The software allows the pump activation to evacuate the manifold and the adsorber column during pretreatments or analysis. In addition to a more effective sample pretreatment, this option allows the emulation of a VPSA-process (Vacuum-Pressure Swing-Adsorption) with one adsorber column.

Mass Flowmeter Option

A mass flowmeter can be included in the manifold to measure the mass flow after the adsorber column. Prior to 100 % breakthrough, the mass flow entering the column can be different from flow coming out, especially in high concentrations. This option is useful when the calculation of flow rate changes is not possible.

Customizable

Several options and accessories are available to further customize mixSorb L analyzers for individual needs and applications. This includes a Kalrez® version with better chemical resistance.

Bypass Connection

Measurement of inlet gas composition before analysis.

Automated Pressure Regulation

Completely programmable for operator-free performance of pressure steps.

Optional Gas Analysis with Coupled Mass Spectrometer

Investigation of ternary gas mixtures and analysis of trace quantities.

Battery-Backed Pressure Display

Monitoring of column pressure, even when power is off.

Safety Guard Sensor

Automatic shut down and warning in PC software after reaching 1 % C_xH_y in manifold (i.e., caused by leaks).

Lighted Safety Indicators

Light in working area switched from white to red, if the column temperature is above 80 °C (helps prevent accidental contact with hot surfaces).

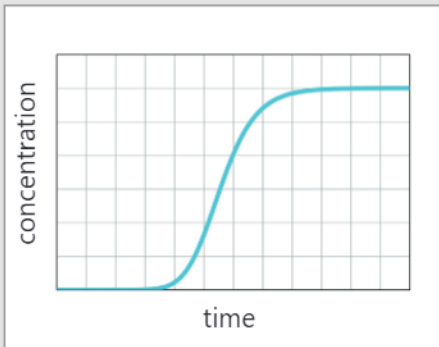

Figure 2 Breakthrough time, mass transfer

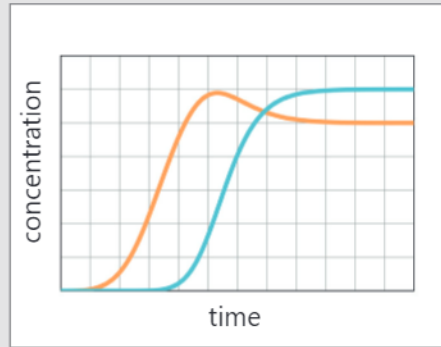

Figure 3 Competitive adsorption, displacement

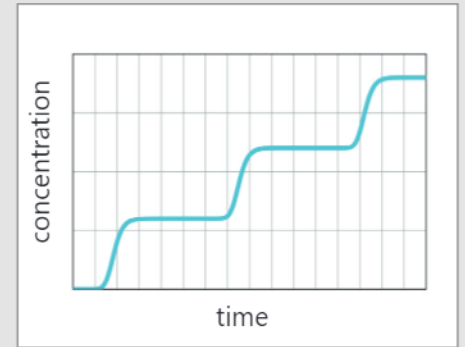

Figure 4 Equilibrium loading, isotherms

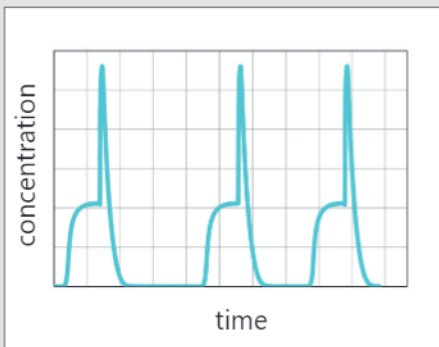

Figure 5 Regenerability, cycle-stability

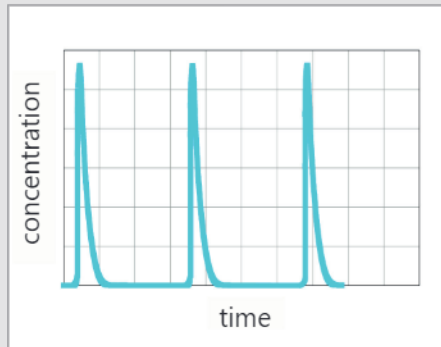

Figure 6 PSA-processes, downscaling

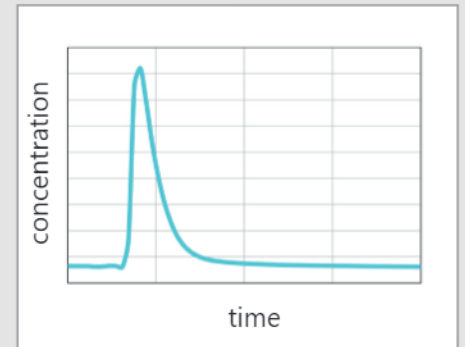

Figure 7 Chromatographic parameters

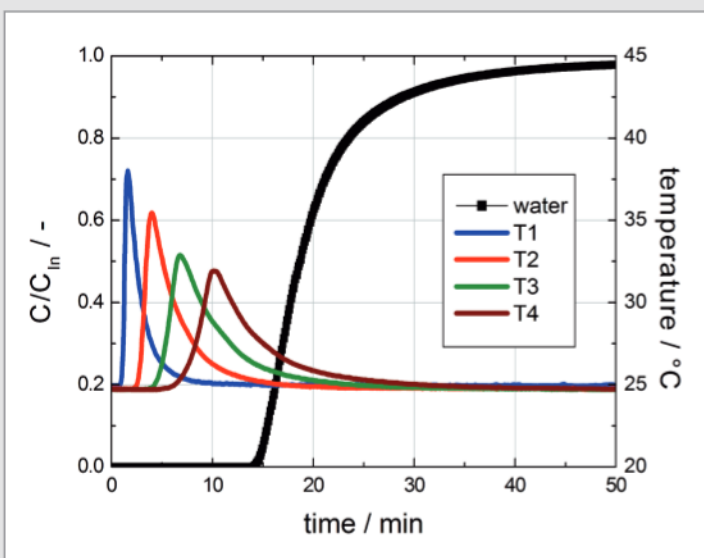

Figure 8 Breakthrough curve of water on 80 g activated carbon at ambient pressure (30 % RH at 25 °C in N₂, gas flow 4000 ml (STP) / min) measured by mixSorb L

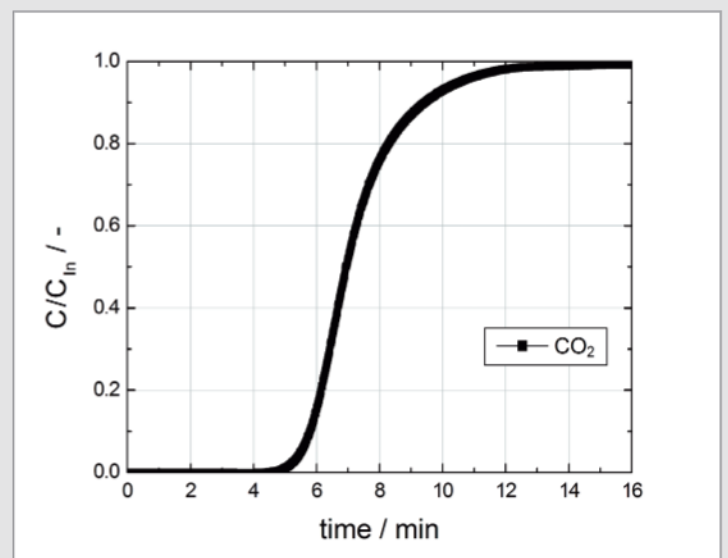

Figure 9 Breakthrough curve of 5 % CO₂ in N₂ on 0.5 g activated carbon at 5 bar (total flow rate 20 ml / min) measured by mixSorb SHP

mixSorb Manager

The user-friendly control software, mixSorb manager, provides real-time control and programmable operation of all system functions, including gas flow rates and composition, flow paths and direction of flow, temperature ramps and dwell times, among other. The software assists the user in the configuration of complex adsorption and desorption sequences. Analysis sequences can be processed fully automated and unattended. The definition of intelligent start/stop criteria provides unprecedented flexibility and facilitates an efficient and economic operation (conserving gas usage). Further software features are:

- Real-time data presentation
- Manual control mode
- Demo mode for operator training and education
- Historical data trending
- System alarm settings
- User account management (hierarchy of user access levels)
- Well-structured log files
- Auto-save function

The status of all sensors and valves, the path and direction of gas flow, and all relevant system information for safe and convenient operation can be viewed at a glance on the controlling PC.

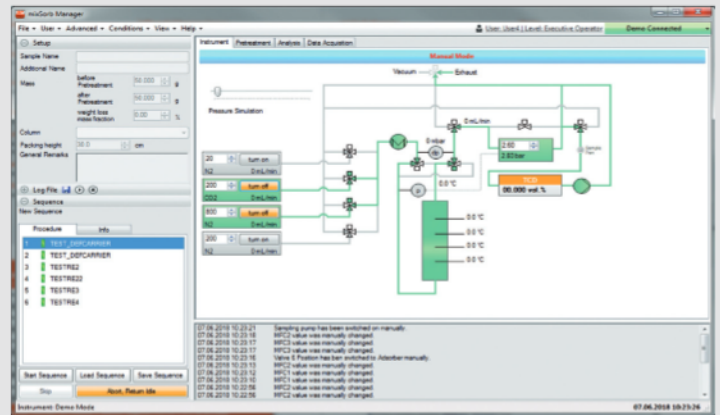

Figure 10 MFC settings can be changed directly in manual mode

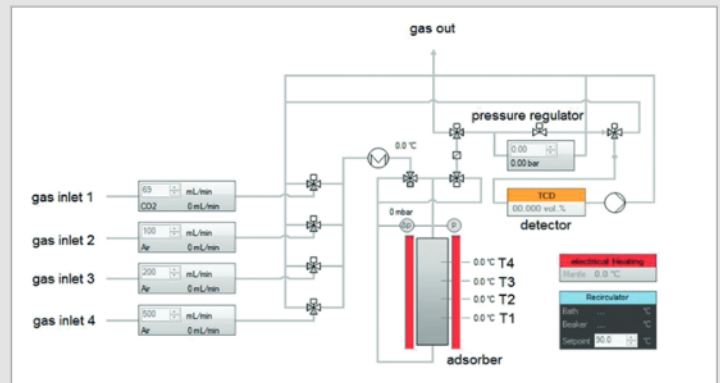

Figure 11 The configuration, installed options, and current status of the system are visible on the main display at a glance

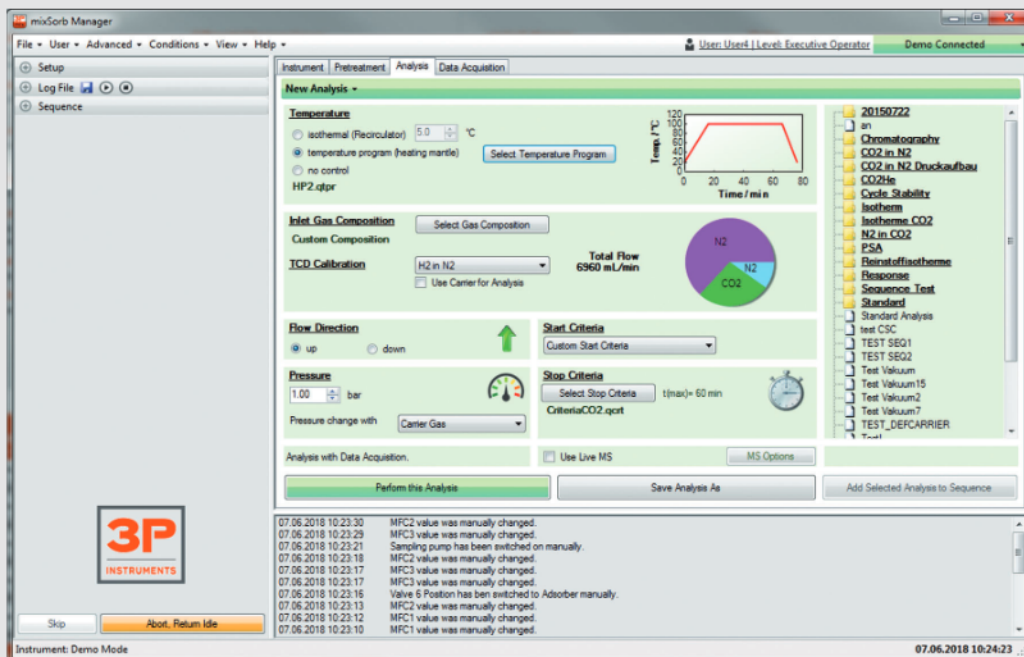

Figure 12 Intuitive control panel for adjusting the analysis parameters

3P sim

The included simulation software 3P sim provides sophisticated data reduction and simulation capabilities, such as:

- Integration of breakthrough curves
- Comprehensive parameter studies
- Simulation and prediction of breakthrough behavior and heat profiles
- Calculation of single- and multi-component adsorption data
- Determination of selectivity, affinity, and kinetic coefficients

Complex calculations or basic research, 3P sim accommodates it all, making it a powerful tool for both industry and academia.

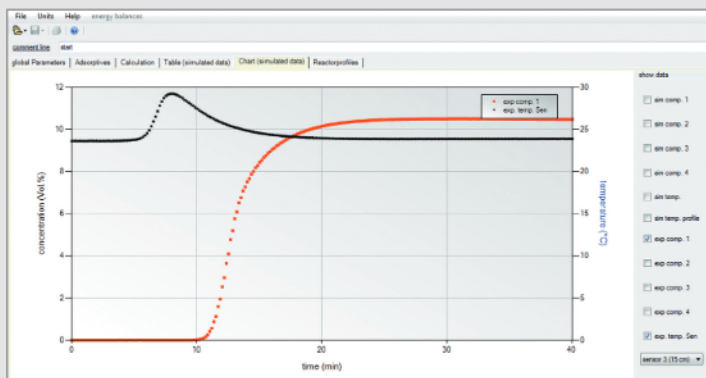

Figure 13 A typical breakthrough curve (red) with the corresponding temperature signal (black) measured at the bottom of the adsorber bed

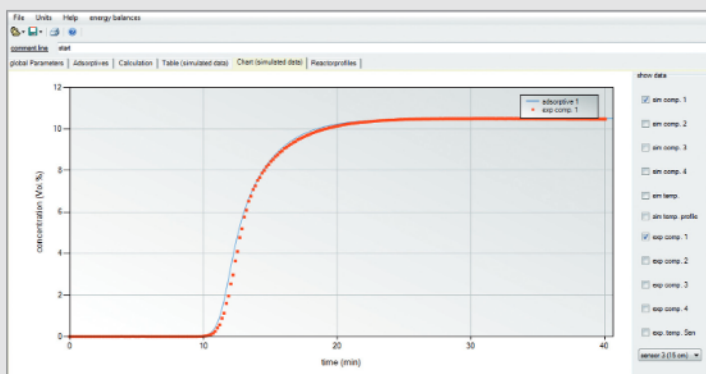

Figure 14 Comparison of a measured breakthrough curve (red) with the simulated breakthrough behavior (blue) computed with 3P sim

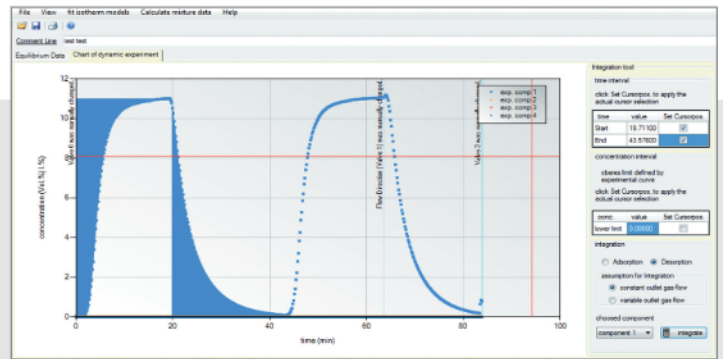

Figure 15 Integration of consecutive ad-/desorption cycles

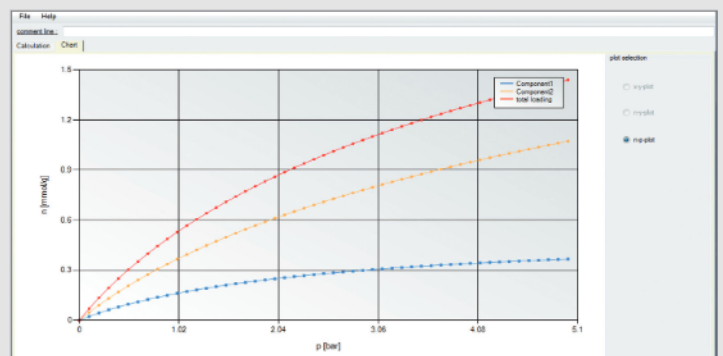

Figure 16 Calculated multi-component sorption equilibria

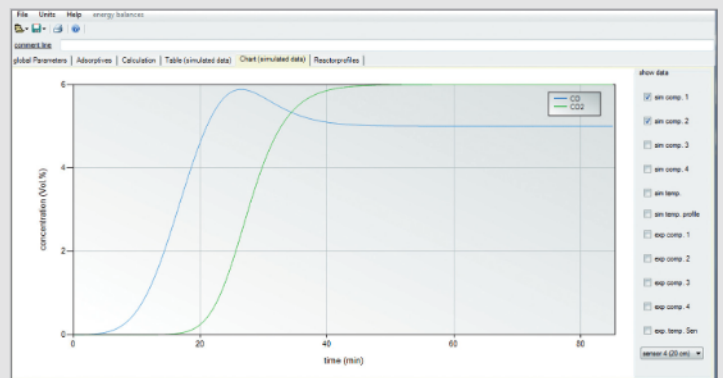

Figure 17 Calculated breakthrough curves of a binary gas mixture in helium carrier gas

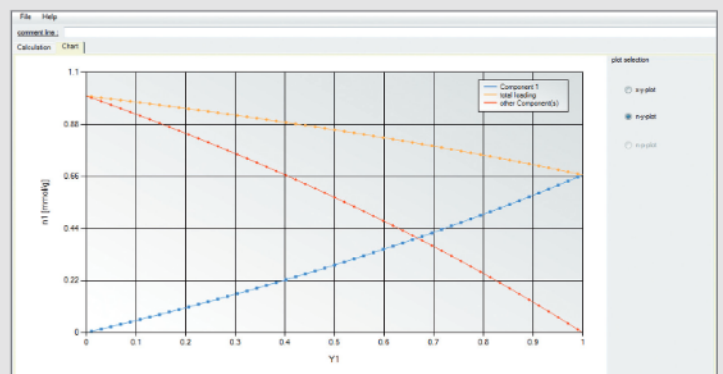

Figure 18 Calculated multi-component sorption equilibria showing total loading (yellow) and partial loading (red and blue)

Your partner in particle characterization

3P Instruments has over 30 years of profound expertise in the characterization of particles, powders and pores



www.dynamicsorption.com

collects and summarizes all the features, advantages, examples and knowledge of dynamic sorption (or flow sorption) methods. Feel free to browse through the pages about breakthrough curves, mixture adsorption and the commercial breakthrough analyzers of the mixSorb series, and download our scientific literature under "Resources".

További információért vegye fel a kapcsolatot velünk!

Kapcsolattartó: dr. Kárpáti Péter

E-mail: karpati.peter@labex.hu

Mobil: 06-30-486-7255

labex ^{30 évesek lettünk!}
Your lab solution partner